

ASSEMBLY INSTRUCTIONS & PARTS MANUAL

36" or 48" Wide Double Entry Letter or Legal Size Imperial Shelving System Model Series: 2476, 2488, 247848, 248848, 3076 & 3088



RETAIN INSTRUCTIONS FOR FUTURE REFERENCE



Starter Unit

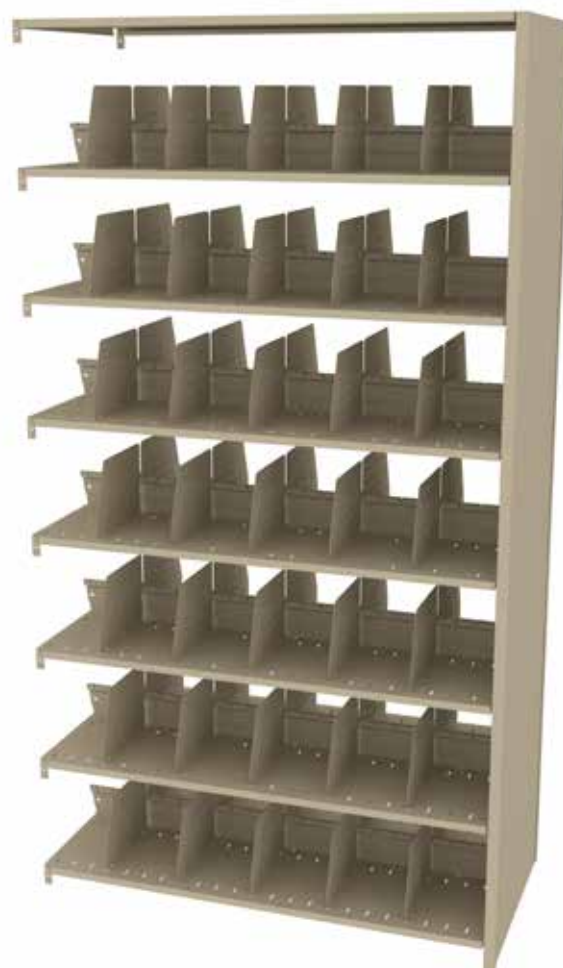

Add-On Unit

GENERAL SAFETY INFORMATION

Some parts may have sharp edges. CARE must be taken when handling various pieces to avoid injury. For safety, wear a pair of work gloves when assembling or performing any maintenance on the units.

LIMITED WARRANTY

Tennsco warrants goods purchased hereunder to be free of defects in materials and workmanship for a period of one (1) year from the date of shipment, hereunder. This warranty shall not apply in the event goods are damaged as a result of misuse, abuse, neglect, accident, improper application, modification or repair by persons not authorized by Seller, where goods are damaged during shipment, or where the date stamps on the goods have been defaced, modified or removed. UNLESS CONSIDERED UNENFORCEABLE OR UNLAWFUL UNDER APPLICABLE LAW:

- a. ALL IMPLIED WARRANTIES, INCLUDING BUT NOT LIMITED TO WARRANTIES OR MERCHANTABILITY AND FITNESS FOR A PARTICULAR PURPOSE ARE HEREBY EXCLUDED:
- b. BUYERS REMEDY, IF ANY, FOR ANY DEFECTIVE GOODS SHALL BE LIMITED TO A REFUND BY SELLER OR REPLACEMENT OF THE GOODS AT SELLER'S OPTION, AND SHALL IN NO EVENT INCLUDE DAMAGES OF ANY KIND, WHETHER INCIDENTAL, CONSEQUENTIAL OR OTHERWISE.

NO GOODS ACCEPTED FOR RETURN WITHOUT PRIOR APPROVAL. Seller shall have the right to inspect any goods claimed to be defective at Buyers place of business or require Buyer to return the goods to Seller for inspection on Seller's premises. Transportation charges covering returned goods will be borne by Seller only if such goods are proven to be defective, are covered by this warranty and are returned within the warranty period stated above.



PROUDLY MADE IN THE U.S.A.

Tennsco LLC., Dickson, TN 37056-1888 • (866) 446-8686

PK-2160419

ASSEMBLY OF IMPERIAL DOUBLE ENTRY UNIT

Two people are recommended for assembly. Approximate assembly time: 30-40 minutes.

Tool Required: Rubber Mallet

The reference numbers used throughout this sheet refer to the illustration on the back cover.

This is to help you to identify the various parts as they are mentioned.

1. Determine whether you will be assembling a single unit, or multiple units joined together. For a single unit, use two "L" uprights (Ref. No. 1). For multiple units, use one "L" upright and one "T" upright (Ref. No. 2).

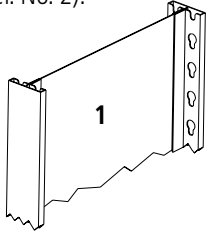

Closed "L" Upright

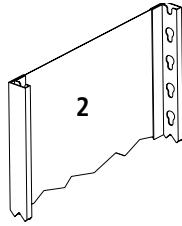

Closed "T" Upright

2. Examine the slots on the two uprights you have selected. When an upright is standing up on end, the narrow part of the keyhole slots should be toward the floor, while the wide part should be toward the top.

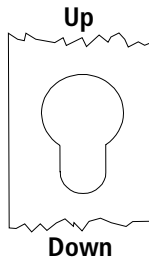

3. After determining which end of the upright is the bottom, attach a plastic foot (Ref. No. 11 or 12) to the bottom of each upright by pressing it into place. Note the differences at right between a foot for an "L" upright and a foot for a "T" upright.

"L" Upright

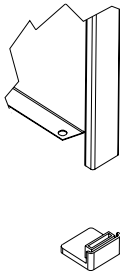

"T" Upright

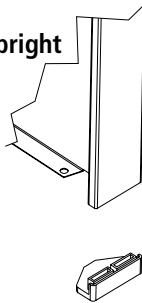

4. Lean one "L" upright against a wall, and temporarily place one shelf support (Ref. No. 3) at approximately eye level to properly space the uprights. Make sure both rivets on the shelf support are fully inserted into the keyhole slots, and are firmly seated at the bottom of the keyhole as shown in step 5.

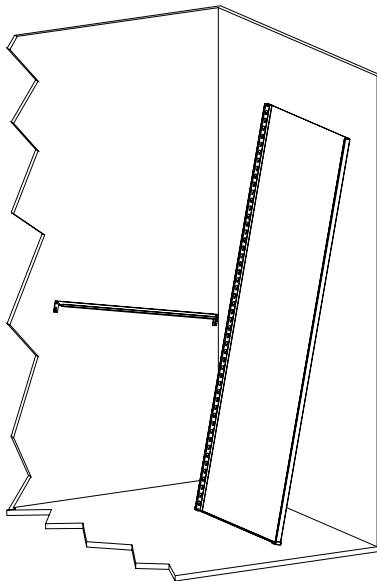

5. To firmly seat shelf supports and backstops, make sure both rivets are fully inserted in the keyhole slots, and firmly seated in the bottom of the slot. A rubber mallet can be helpful in accomplishing this.

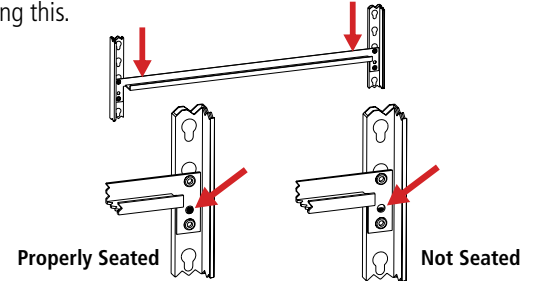

NOTE: Supports are not fully seated unless you can see an open space through the hole in the shelf support as shown above.

6. Hold a second "L" upright (or a "T" upright if you are assembling multiple units) approximately 36" away. Pull the first upright away from the wall using the shelf support you attached in step 4, and insert the other end of the shelf support into the second upright.

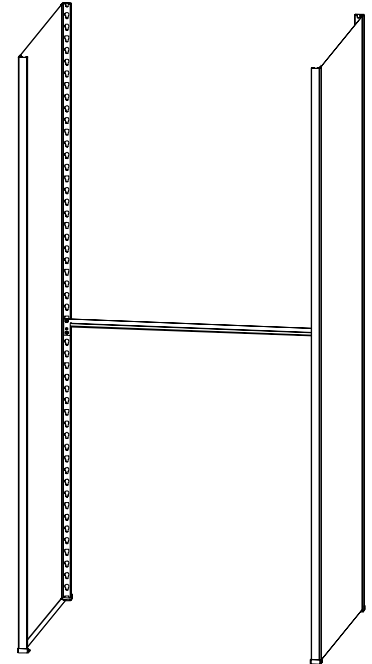

NOTE: Take care not to let the uprights fall, as they are not stable until this step is completed.

7. Place a shelf support at the rear of the unit in the bottom keyhole slots, in the same way you placed the shelf support in steps 4 through 6. Then, place a second shelf support at bottom front of unit.

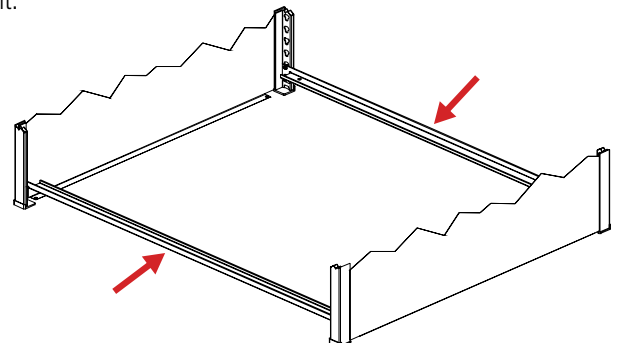

- 8.** Place a shelf reinforcement (Ref. No. 8) across the two shelf supports. The slot in each end of the shelf reinforcement should fit over the ridge of the shelf support.

NOTE: 48" wide units will use two shelf reinforcements per shelf level, equally spaced.

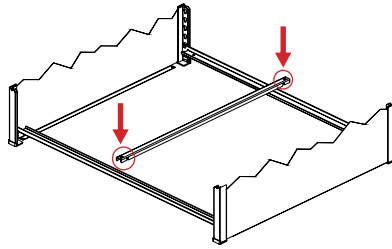

- 9.** Attach one center stop (Ref. No. 4) to one of the slotted shelves (Ref. No. 5) by aligning the three holes in the center stop flange with the holes in the center of the shelf. Attach with three 10-24 x 1/2" bolts and nuts (Ref. Nos. 9 & 10).

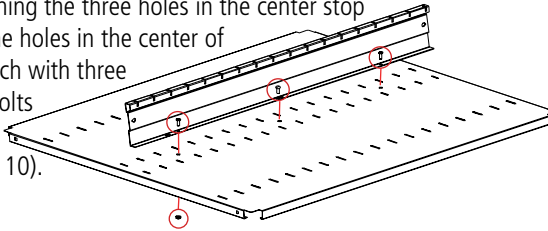

- 10.** Place the shelf, with the center stop attached, onto the unit by lowering it over the top of the shelf supports. The edges of the shelf should fit over the top of the shelf supports, hiding them from view.

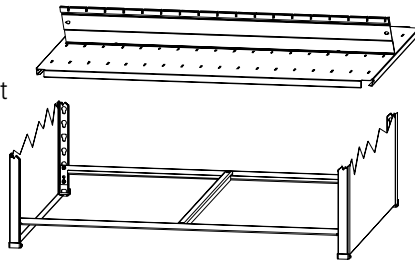

- 11.** Continue the assembly by placing supports, shelves, reinforcements and center stops as described in steps 7 through 10. The recommended spacing between shelves is twelve inches, which equals six open keyhole slots between supports. If necessary, move the temporarily places reinforcement from step 6.

NOTE: The plain shelf (without slots) is for the unit top.

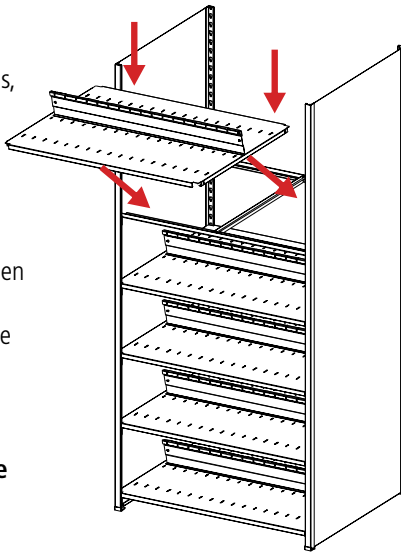

- 12.** The top shelf supports and top shelf (Ref. No. 6) should be installed flush with the upright top. Note that the top shelf has no divider slots. No shelf reinforcements are needed under top shelf.

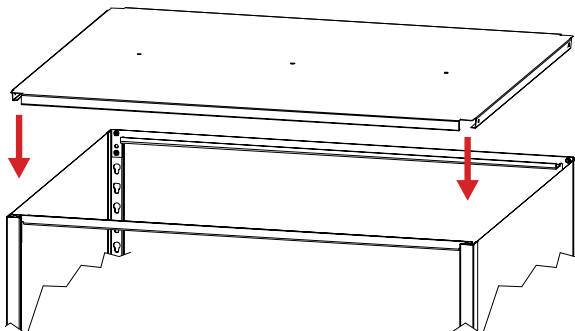

- 13.** Insert shelf dividers (Ref. No. 7) by placing dividers into slots on shelf and then hooking into the slot in the back stop. You have been provided with enough dividers for ten per shelf level (five on each side of the shelf), but these can be placed in whatever position most suits your needs.

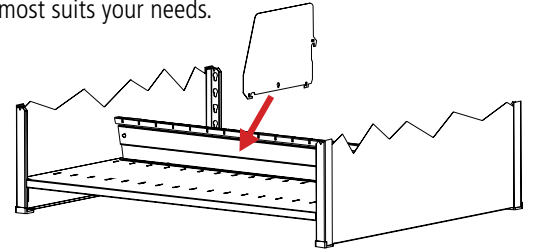

- 14.** If you are assembling only a single unit, assembly is now complete (shown below left). If you are assembling multiple units joined together, your starter unit should have been assembled with a "T" upright (shown below right), as described in step 1. Continue with step 15.

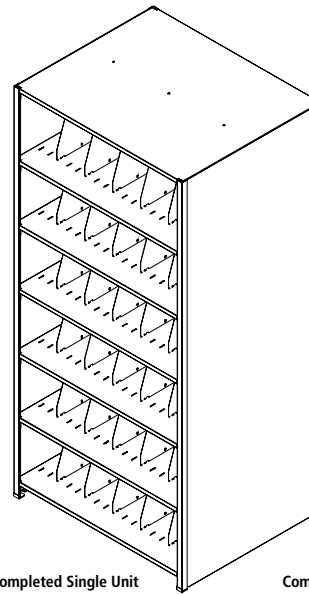

Completed Single Unit

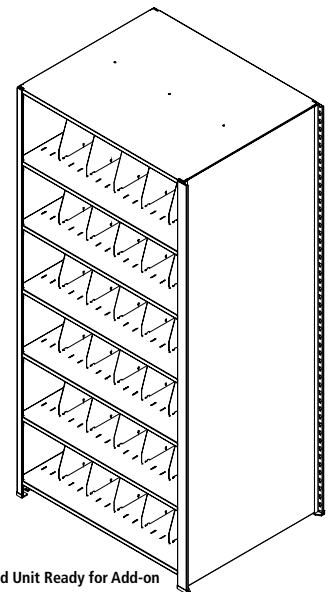

Completed Unit Ready for Add-on

- 15.** Repeat steps 4 through 13, adding the shelf supports to the "T" upright already in place on the unit.

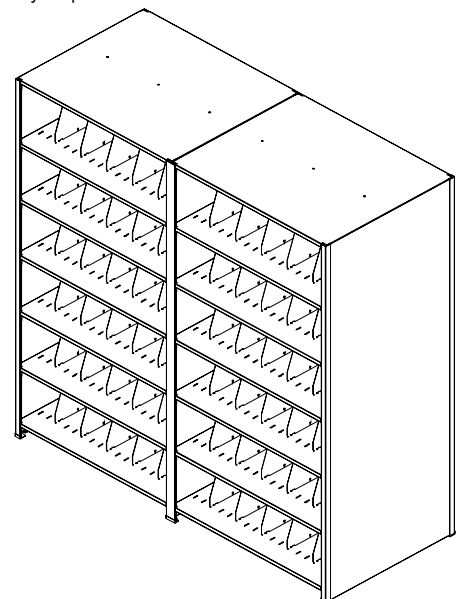

REPLACEMENT PARTS

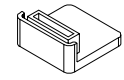
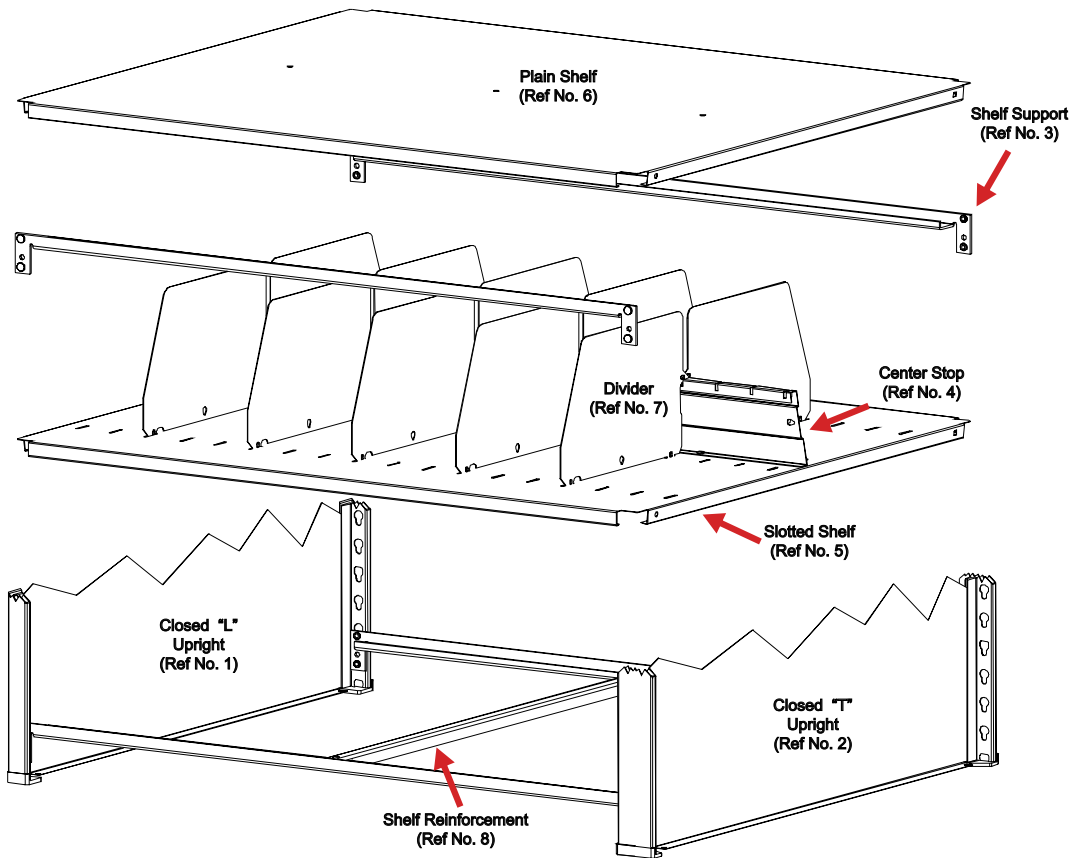

Plastic Foot for "L" Upright (Ref No. 11)

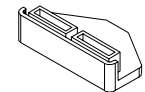

Plastic Foot for "T" Upright (Ref No. 12)

REF. NO.	DESCRIPTION	PART NO.	36W x 24D x 76H 6 Openings QUANTITY		36W x 24D x 88H 7 Openings QUANTITY		48W x 24D x 76H 6 Openings QUANTITY		48W x 24D x 88H 7 Openings QUANTITY		36W x 30D x 76H 6 Openings QUANTITY		36W x 30D x 88H 7 Openings QUANTITY	
			Starter 2476PC	Add-On 2476AC	Starter 2488PC	Add-On 2488AC	Starter 247648PC	Add-On 247648AC	Starter 248848PC	Add-On 248848AC	Starter 3076PC	Add-On 3076AC	Starter 3088PC	Add-On 3088AC
1	Closed "L" Upright	OR 2476LC	2	--	--	--	2	--	--	--	--	--	--	--
	Closed "L" Upright	OR 2488LC	--	--	2	--	--	--	2	--	--	--	--	--
	Closed "L" Upright	OR 3076LC	--	--	--	--	--	--	--	2	--	--	--	--
	Closed "L" Upright	3088LC	--	--	--	--	--	--	--	--	--	2	--	--
2	Closed "T" Upright	OR 2476TC	--	1	--	--	--	1	--	--	--	--	--	--
	Closed "T" Upright	OR 2488TC	--	--	--	1	--	--	1	--	--	--	--	--
	Closed "T" Upright	OR 3076TC	--	--	--	--	--	--	--	1	--	--	--	--
	Closed "T" Upright	3088TC	--	--	--	--	--	--	--	--	--	--	1	--
3	Shelf Support	OR TS-3614	14	14	16	16	--	--	--	--	14	14	16	16
	Shelf Support	TS-4811	--	--	--	--	14	14	16	16	--	--	--	--
4	Center Stop	OR CS-36	6	6	7	7	--	--	--	--	6	6	7	7
	Center Stop	CS-48	--	--	--	--	6	6	7	7	--	--	--	--
5	Slotted Shelf	OR TQD2-3624	6	6	7	7	--	--	--	--	--	--	--	--
	Slotted Shelf	OR TQD2-4824	--	--	--	--	6	6	7	7	--	--	--	--
	Slotted Shelf	OR TQD2-3630	--	--	--	--	--	--	--	--	6	6	7	7
	Slotted Shelf	TQD2-4830	--	--	--	--	--	--	--	--	--	--	--	--
6	Plain Shelf	OR T2-3624	1	1	1	1	--	--	--	--	--	--	--	--
	Plain Shelf	OR T2-4824	--	--	--	--	1	1	1	1	--	--	--	--
	Plain Shelf	OR T2-3630	--	--	--	--	--	--	--	--	1	1	1	1
	Plain Shelf	T2-4830	--	--	--	--	--	--	--	--	--	--	--	--
7	Divider	FD-1108	60	60	70	70	60	60	70	70	60	60	70	70
	Shelf Reinforcement	TR-24	6	6	7	7	12	12	14	14	--	--	--	--
8	Shelf Reinforcement	OR TR-30	--	--	--	--	--	--	--	--	6	6	7	7
	Shelf Reinforcement	TR-30	--	--	--	--	--	--	--	--	--	--	--	--
9	10-24 x 1/2" Bolt ♦	**	18	18	21	21	18	18	21	21	18	18	21	21
10	10-24 x 1/2" Hex Nut ♦	**	18	18	21	21	18	18	21	21	18	18	21	21
11	Plastic Foot for "L" Upright	LTNF-L	4	--	4	--	4	--	4	--	4	--	4	--
12	Plastic Foot for "T" Upright	LTNF-T	--	2	--	2	--	2	--	2	--	2	--	2

♦ Not Shown

** Available Locally

Tennsco makes every effort to ensure that all units ship complete with all parts and arrive undamaged. However, should your unit contain missing or damaged parts, please contact your purchase location.